

## **MICROFLAT SERIES**

### **TYPES CM..F SM..F**

### **MM..F TM..F**

**AUTOMATIC CONTROL SYSTEMS FOR  
GAS BURNERS AND GAS BURNING  
APPLIANCES WITH OR WITHOUT FAN  
AND WITH BUILT-IN ANTI-EMISSIONS  
FILTER**

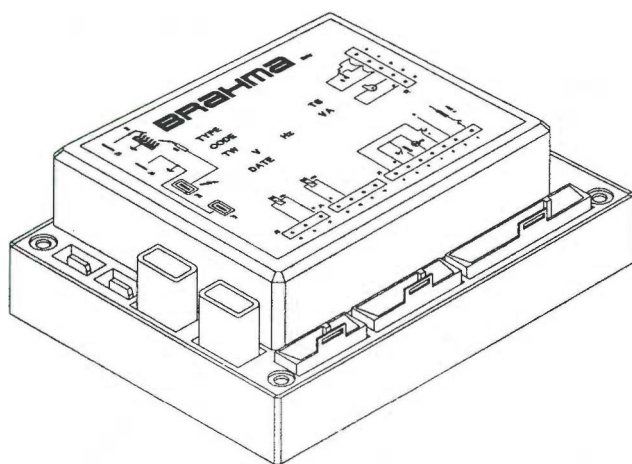

#### **Application**

This range of electronic gas burner control systems has been specifically designed for atmospheric burners for intermittent operation (systems for non-permanent operation), with or without fan in the combustion circuit. All these controls are provided with non-volatile lockout, i.e. a restart from the safety shutdown condition can only be accomplished by a manual reset of the system.

The automatic burner control units of this series are suitable for:

- combi boilers;
- heating boilers;
- warm air generators;
- radiant heaters;
- water heaters.

Thanks to their design and variety of models, they can also be used for the automation of ovens, cookers and in gas firing installations with atmospheric burner in general.

#### **Features**

Table 1 shows the main features of this series. Other important features are:

- EC certification (CE Reg. N° 63AQ0625) in accordance with Gas Appliance Directives 90/396 and 93/68;
- in accordance with EN 298 (European standard for automatic gas burner control systems and flame detectors);
- completely solid and high efficient inbuilt ignition device with built-in E.M. filter;
- possibility of mounting a resistor ( $0 + 220 \text{ ohm}$ ) in series to the valve output, in case the valves operate with direct current obtained through the rectification of the supply alternate current by means of one or more diodes;
- possibility of mounting a resistor ( $0 + 470 \text{ Kohm}$ ) in series to the lockout signal output, to avoid possible damages to the control in case the connections of the reset button and the connections of the lockout signal are inverted;
- two independent safety contacts in series on the gas valve output;
- auxiliary contact for low power ignition or main gas valve control for intermittent pilot systems; this contact is not isolated from the main supply voltage by reinforced isolation, therefore the relay contact is not suitable to supply SELV circuits - Safety Extra Low Voltage, e.g. 24V;
- flame monitoring by the rectification property of the flame: ionization.

TABLE 1

	Burners				Features			Options	classification code according to EN298 (4)
	single flame	dual flame	atmospheric without fan	atmospheric with fan	monoelectrode	auxiliary contact (1)	safety thermostat provision (2)	connectors type molex (3)	
CM 11F	*		*					*	AMCLXN
CM 12F		*	*					*	ATCLXN
CM 31F	*			*				*	FMCLXN
CM 32F		*		*				*	FTCLXN
SM 11F		*	*			*		*	ATCLXN
SM 31F		*	*	*	*	*		*	FTCLXN
MM 11F	*		*		*			*	AMCLXN
MM 12F		*	*		*			*	ATCLXN
MM 51F		*	*		*	*		*	ATCLXN
MM 31F	*		*	*	*			*	FMCLXN
MM 32F		*	*	*	*			*	FTCLXN
TM 11F	*		*			*		*	AMCLXN
TM 12F		*	*		*	*		*	ATCLXN
TM 31F	*		*	*	*	*		*	FMCLXN
TM 32F		*	*	*	*	*		*	FTCLXN

(1): This contact is not isolated from the main supply voltage by reinforced isolation, therefore the relay contact is not suitable to supply SELV circuits - Safety Extra Low Voltage.

(2): Safety thermostat opening causes cycle repetition and non-volatile lockout.

(3): Standard connectors are stelvio-stocko models, see Fig.2.

(4): Flame failure during TS causes spark restoration.

#### TECHNICAL DATA

Supply Voltage: 220-240V-50/60Hz  
on request: 110/120V-50/60Hz

Operating temperature range: -20°C +60°C

Ambient humidity: 95% max at 40°C

Protection degree: IP 00

Times:

- Prepurge or waiting time (TW): 1,5 ... 40 s

- Safety time (TS): 3 ... 120 s

- Drop out time on running flame failure: < 1 s

The times given on the burner control label correspond to the values guaranteed. The actual values slightly differ from the values given, pre-purge and waiting time is in fact longer and safety time shorter than their nominal values.

#### Power consumption, at starting up:

types without burner 10 VA

types with burner 12 VA

#### Power consumption, running:

types without burner 7 VA

type with burner 9 VA

#### Contact rating:

-Thermostat: 4 A  $\cos \varphi \geq 0.4$

-VG1: 0.5 A  $\cos \varphi \geq 0.4$

-VG2: 0.5 A  $\cos \varphi \geq 0.4$

-Fan: 1 A  $\cos \varphi \geq 0.4$

-Alarm: 1 A  $\cos \varphi = 1$

-Auxiliary contact: 0.5 A  $\cos \varphi \geq 0.4$

Max. length of the cables of external components: 1m

Internal fuse rating: 4 A Fast

External fuse rating: 3.15 A Fast

#### Flame control:

The ionization flame detection device makes use of the rectification property of the flame.

The ionization flame detector device is not a safe to touch output (no provision with protective impedances).

-Minimum ionization current: 0.5 $\mu$ A

on request: 1.2 $\mu$ A/2.5 $\mu$ A

-Recommended ionization current: 3 + 5 times the minimum ionization current

-Max. length of the cable: 1m

-Minimum insulation resistance of the cable and the flame detector device to earth:  $\geq 50M\Omega$

-Max. parasitic capacitance of the detection probe:  $\leq 1nF$

-Max. short circuit current: < 200 $\mu$ A AC

#### Ignitor:

- Peak ignition voltage: 15 KV at 30pF loading  
on request: 12/18 KV

-Peak current: 800 mA

-Spark repetition rate: 25 Hz

on request: 1 ... 8/10/12/16 Hz

-Max.length of the cable: 2 m

-Spark gap recommended: 2-4 mm

-Consumption: 2,5 VA

-Spark energy: 20 mJ

Weight: 170 g

#### CONSTRUCTION

The enclosure made of plastic material and the varnishing of the circuit board protect the control from mechanical damages, dust and dirt from the conditions of installation.

Through the use of a board assembled with surface mounted components and of a new patented circuit generating the ignition spark which limits the EM to a minimum, it has been possible to reduce the printed circuit board dimensions and to realize even the most complex executions with extremely compact dimensions.

A varistor protects the control from voltage transient on the main supply, caused for example by discharges such as thunderbolts. An internal fuse protects the relays of the control box in case of short circuits on the outputs (valves, fan and lockout signal). In any case the control must be protected with a fast blow external fuse suitable to the load connected and never exceeding 3.15 A.

#### Overall Dimensions

The control units of the MICROFLAT series can be supplied in different executions but with the same enclosure. The following figure (Fig. 1) shows the overall dimensions of the controls.

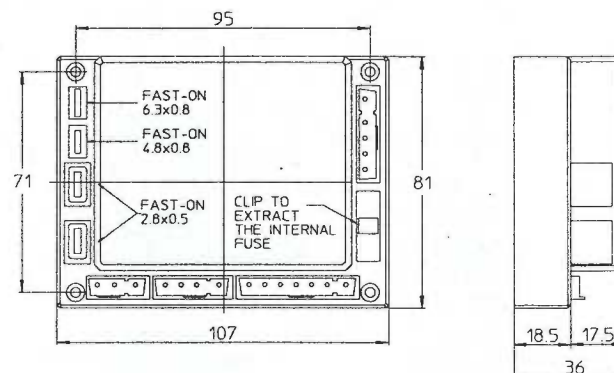

Fig.1

### Possible fixing

top: Self-tapping screw UNI6951AB 2.9x22  
M3x22 screw 2UNI6107

bottom: Screwplast self-forming screw ISO0003 F 3.5x13  
Screwplast self-forming screw ISO0003 F 3.9x13

### Accessories

The control units are usually supplied with a kit of female connectors and/or a reset button (see Fig.2 and Fig.3).  
Do not fit terminals and female connectors of different types.

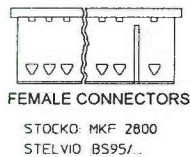
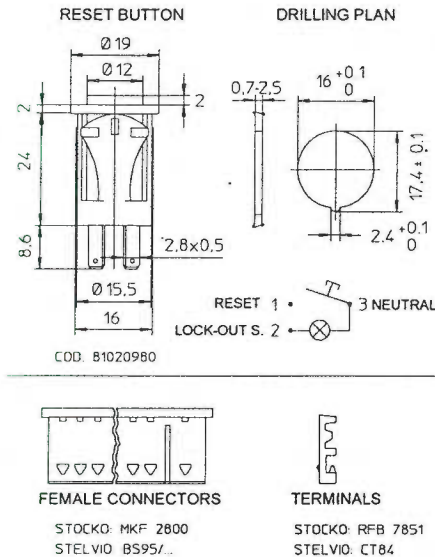

Fig.2

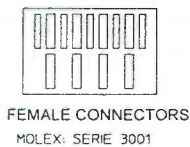

Fig.3

### Connection

The use of non-reversible connectors with a different number of poles makes the connection easy and reliable. One-way fast-on connectors of different sizes for ignition and detection electrodes permit their easy installation and replacement.

The dual output ignition device allows spark generation on one point (3a), two points (3b) or between two electrodes isolated from the metal frame of the burner (3c), see Fig.4. The configuration (3c) assures a limited EM emission.

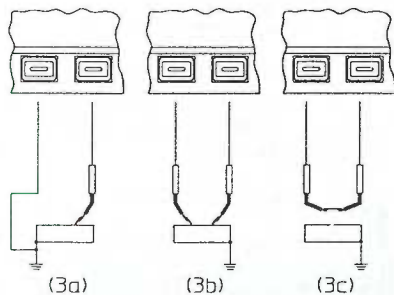

Fig.4

Provisions such as strain relieves, sufficient earth terminals and neutral terminals should be present in the appliance or in external connection boxes. With all types it is possible to execute the connection with a J3 connector as shown in Fig.5.

Types TM..F are prearranged for the connection of a safety thermostat ST which stops the supply to the gas valve VG1 and causes a safety shutdown after a delay which is the sum of waiting (pre-purge) and safety times.

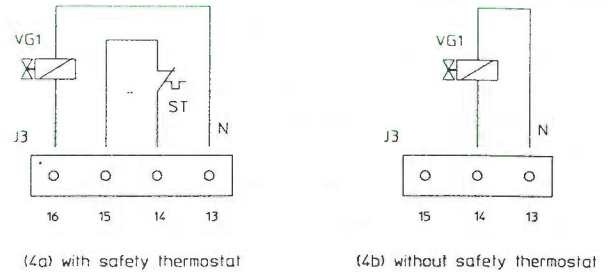

Fig.5

### DIRECTIONS FOR USE

- For technical and safety reasons a regulation shutdown must occur every 24 hours (systems for non-permanent operation).
- Automatic controls are safety devices and must not be opened. The manufacturer's responsibility and guarantee are invalidated if the control is opened.
- The control must be connected and disconnected only after switching off the main power.
- The control can be mounted in any position.
- Avoid exposing the control unit to dripping water.
- Ventilation and the lowest temperature ensures the longest life of the control.
- Make sure that the type (code and times) you are using is correct before installing or replacing the control.
- The gas appliance on which the control is installed must provide adequate protection against the risk of electrical shock (at least IP20).

### Electrical installation

- The applicable national regulation and the European standards (e.g. EN 60335-1/prEN 50165) regarding electrical safety must be respected.
- Live and neutral should be connected correctly, a mistake could cause a dangerous situation, i.e. the valves would still be live with the thermostats and limits switched off. If live-neutral polarity is not respected the control performs a non-volatile lockout at the end of the safety time at starting up.
- Before starting the system check the cables carefully. Wrong connections can damage the control and compromise the safety.
- The earth terminal of the control, the metal frame of the burner and the earth on the main supply must be well connected.
- Avoid putting the detection cable close to power or ignition cables.
- Use a heat resistant cable for the detection probe, well insulated to the ground and protected from possible moisture (or water in general).
- Use an ignition cable as short and straight as possible and keep it far from other conductors to reduce the emission of interference (max.length <2m and insulation voltage >25KV).

In case of live-neutral network with unearthed neutral or live-live network (with centre of the star not earthed) the control can operate correctly by means of a built-in resistor. In case of "partial" short circuits or bad insulation between live and earth the voltage on the ionization probe can be reduced until it causes the lockout of the control, because of the impossibility of detecting the flame signal. In the presence of this kind of network it is advisable to use our step-up transformer type AR1.

## Checking at start

Always check the control before the first start and also after any substitutions or a long period of non-operation of the system. Before any ignition attempt make sure that the combustion chamber is free from gas.

Then make sure that:

- if the starting attempt occurs without gas supply the control performs a non-volatile lockout after TS;
- when stopping the gas flow while the control is in running state the supply to the gas valve is interrupted within 1 second, and after a recycling the control proceeds to a non-volatile lockout;
- operating times and sequence are suitable;
- the level of the flame signal is sufficient, see Fig.6 for the measuring test;
- the ignition probe(s) is (are) adjusted in the most stable way for a spark gap between 2-4 mm;
- the intervention of limiters or safety devices causes a safety shutdown according to the application.

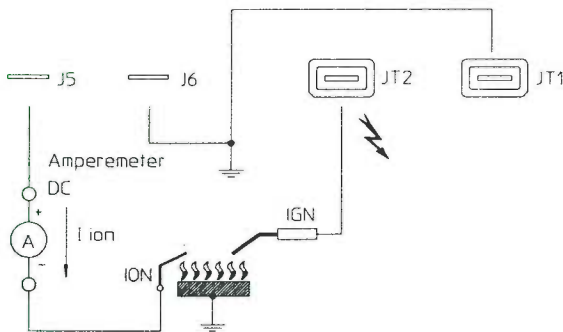

Fig.6

## Operation

At every start the control unit proceeds to a self-checking of its own components. During the waiting or prepurge time (TW) the operation of the flame signal amplifier is checked: the internal circuit makes a test of the flame signal amplifier circuit. A parasitic flame signal or a fault in the amplifier prevent the control from starting.

In the types with fan control, before the elapsing of the prepurge time, the air pressure switch contacts are checked to prove their "no air flow" state.

Only if the test is positive the fan is started and with the air pressure switch in "air flow" state the prepurge time begins. At the end of the waiting or prepurge time the VG1 gas valve is energized and the ignition device is operated. In this way the safety time (TS) begins. If the presence of flame is detected during the safety time the ignition device is inhibited and, in the suitable models, the main valve (VG2) is supplied or the independent auxiliary contact will switch from off to flame detected position.

On the contrary, if the control detect no presence of flame by the end of TS, it proceeds to non-volatile lockout, the VG1 gas valve and the ignition device are switched off while the lockout signal output is supplied.

Flame failure during the safety time causes the ignition device to be activated within one second.

The attached diagrams are useful to understand how each control operates.

## Reset of the control

When a control has gone to non-volatile lockout, a ten-second delay should be allowed before attempting to reset the control unit; if this time is not observed the control may not reset correctly.

# CONTROLS DENOMINATION

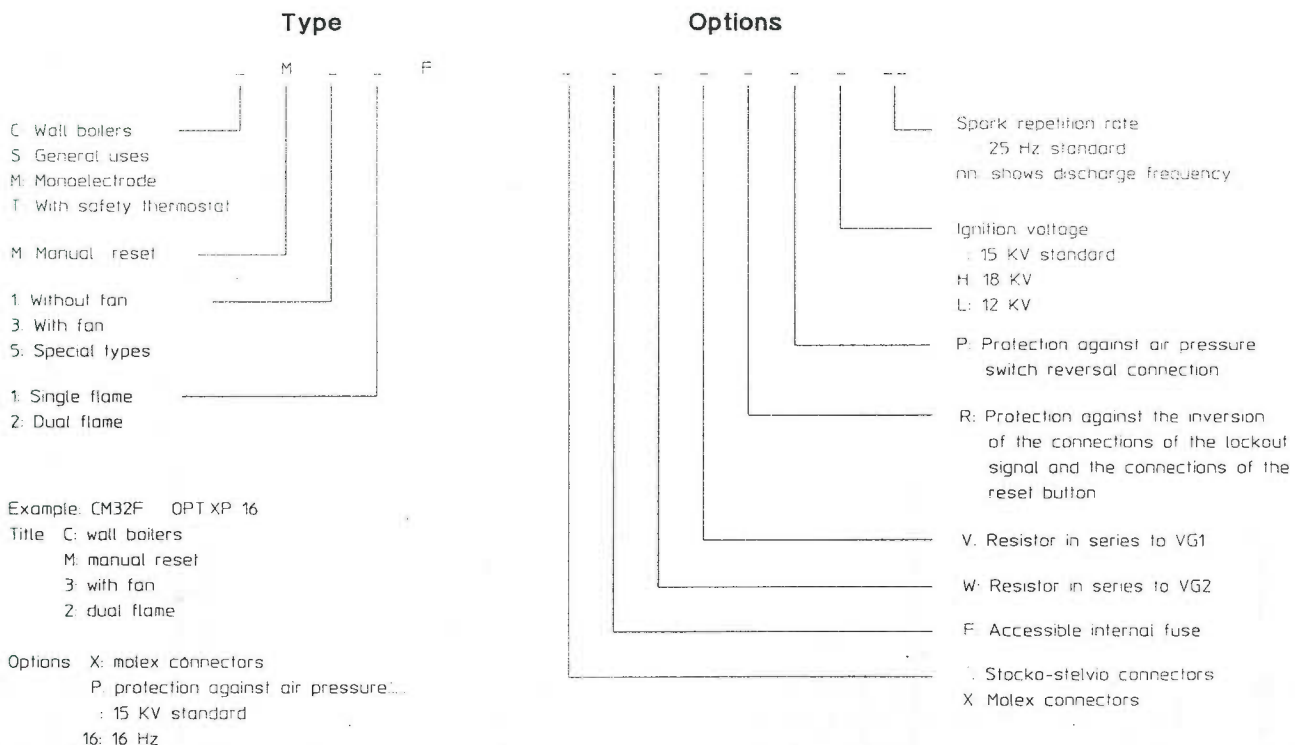

# OPERATING CYCLES

## Type without fan

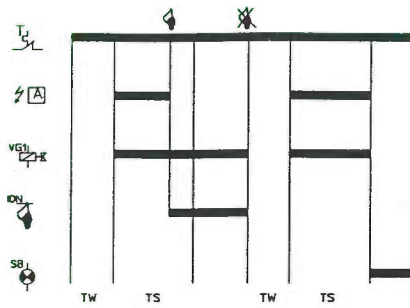

TYPE CM11F - MM11F

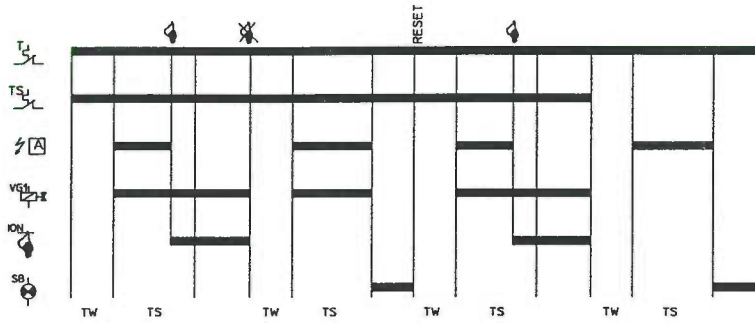

TYPE TM11F

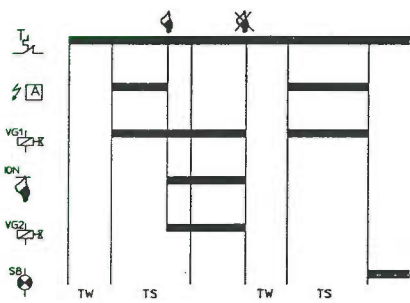

TYPE CM12F - MM12F

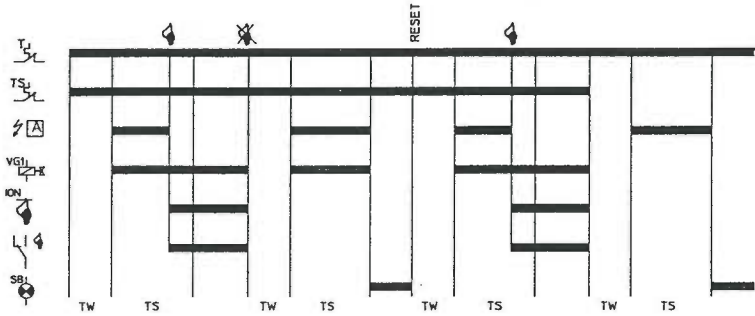

TYPE TM12F

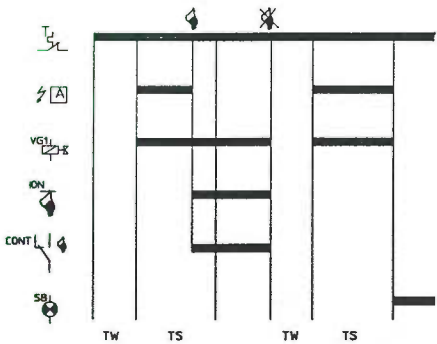

TYPE SM11F - MM51F

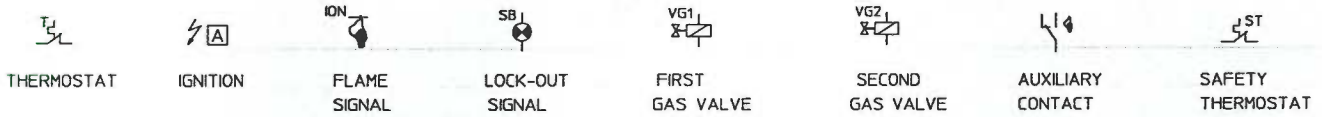

# OPERATING CYCLES

## Types with fan

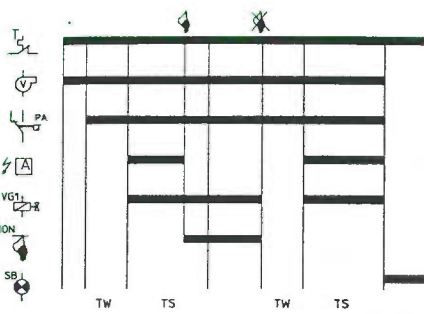

TYPE CM31F - MM31F

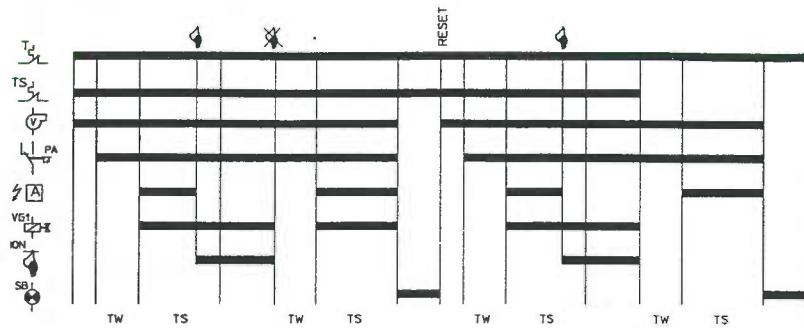

TYPE TM31F

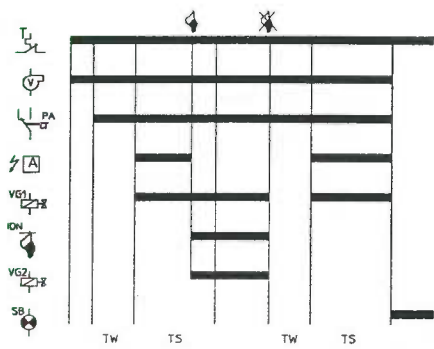

TYPE CM32F - MM32F

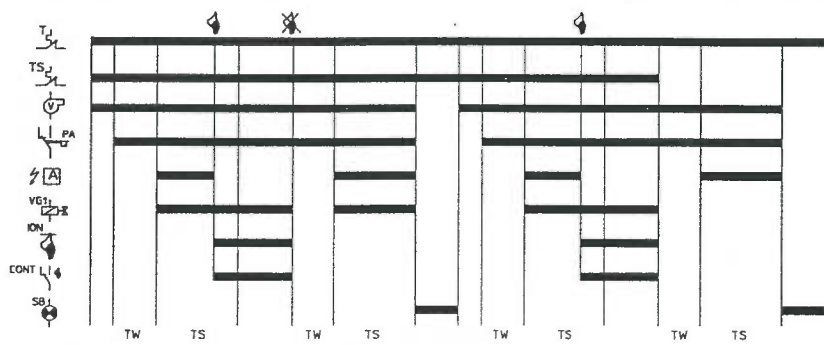

TYPE TM32F

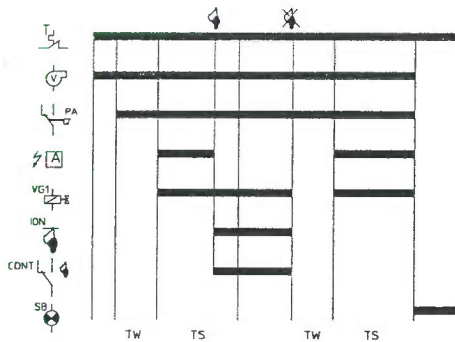

TYPE SM31F



THERMOSTAT



FAN



AIR PRESSURE  
SWITCH



IGNITION



FLAME  
SIGNAL



LOCK-OUT  
SIGNAL



FIRST  
GAS VALVE



SECOND  
GAS VALVE



AUXILIARY  
CONTACT



SAFETY  
THERMOSTAT

**Microflat Series**  
**Types CM..F SM..F MM..F TM..F**

# CONNECTION DIAGRAMS

## Types without fan

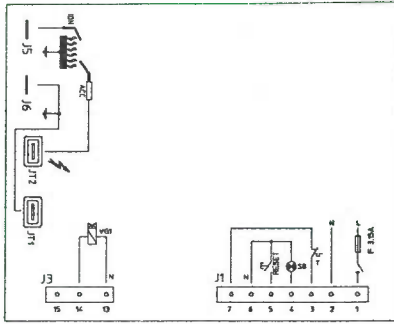

TYPE CM11F

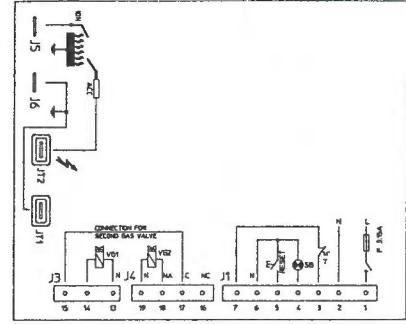

TYPE SM11F

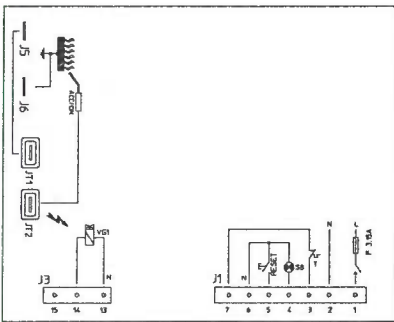

TYPE MM11F

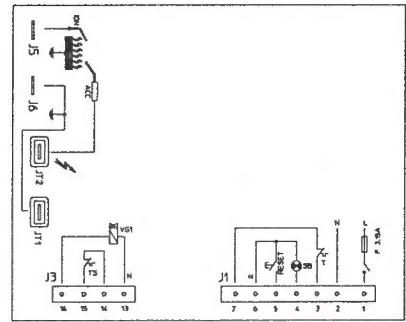

TYPE TM11F

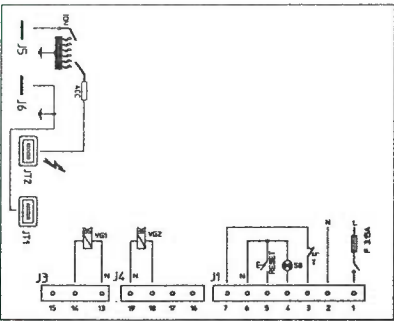

TYPE CM12F

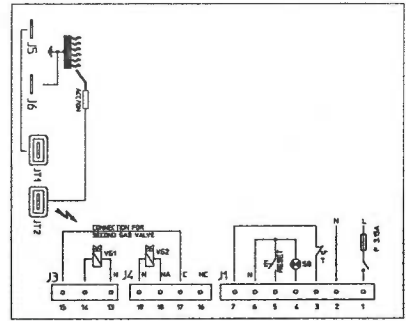

TYPE MM51F

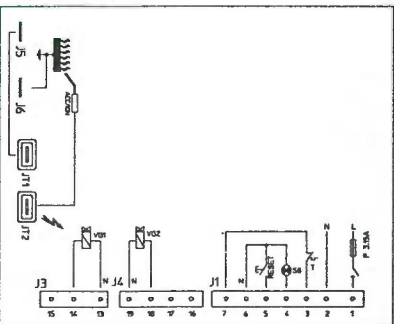

TYPE MM12F

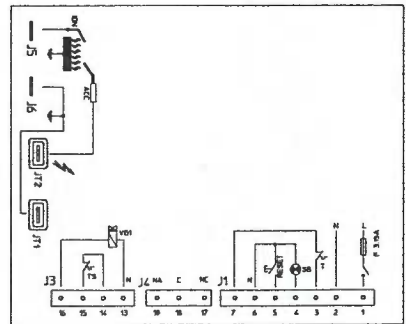

TYPE TM12F

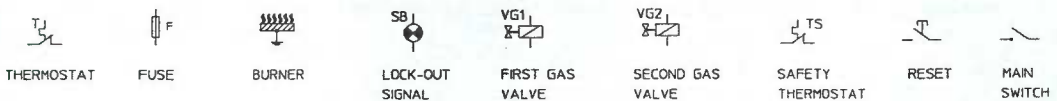

**NOTE:** the limit thermostat has to be wired in series to the live.

# CONNECTION DIAGRAMS

## Type with fan

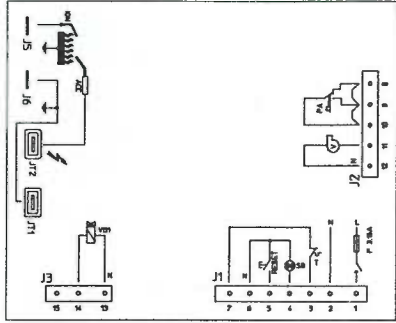

TYPE CM31F

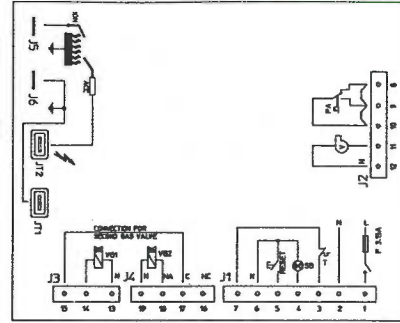

TYPE SM31F

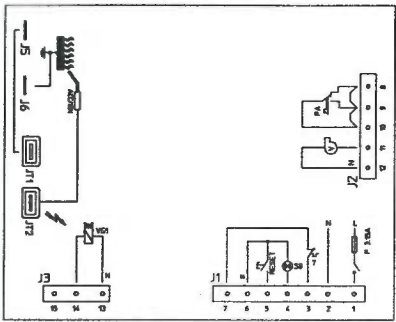

TYPE MM31F

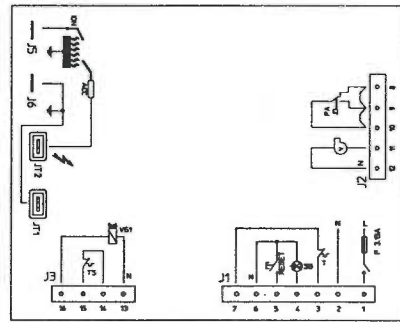

TYPE TM31F

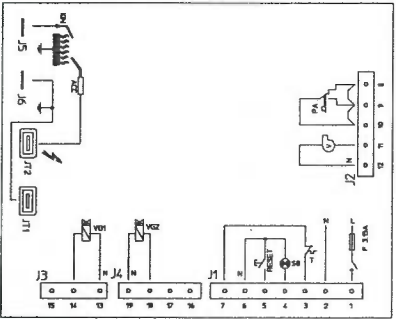

TYPE CM32F

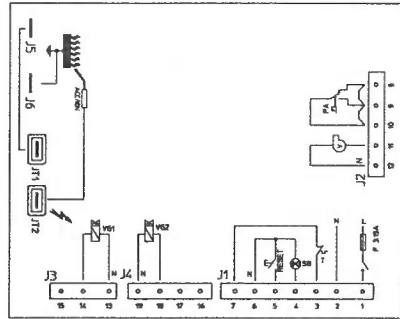

TYPE MM32F

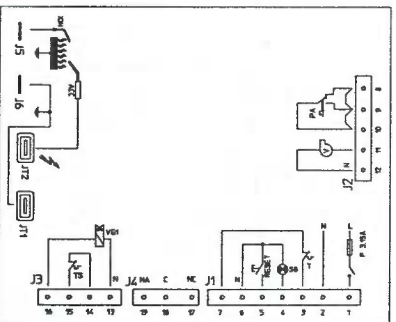

TYPE TM32F



**NOTE:** the limit thermostat has to be wired in series to the live.