

BRULEUR FUEL 1 ALLURE
 EINSTUFIGE ÖLFEUERUNGS BRENNER
 ONE STAGE OIL BURNER

MA 55





EQUIPEMENT POUR BRULEUR A MAZOUT	AVEC ELECTROVANNE	AVEC PREVENTILATION	AVEC PRE- ET POST-ALLUMAGE
ÖLFEUERUNGS STEUERGERAET	MIT MAGNETVENTIL	MIT VORLÜFTUNG	MIT VOR-UND NACHZÜNDUNG
CONTROL UNIT FOR OIL BURNER	WITH SOLENOID VALVE	WITH PREPURGE	WITH PRE-AND POST-IGNITION

CONTROLE DES LUMIERES PARASITES AVEC INTERDICTION DE DEMARRAGE ET MISE EN SECURITE.





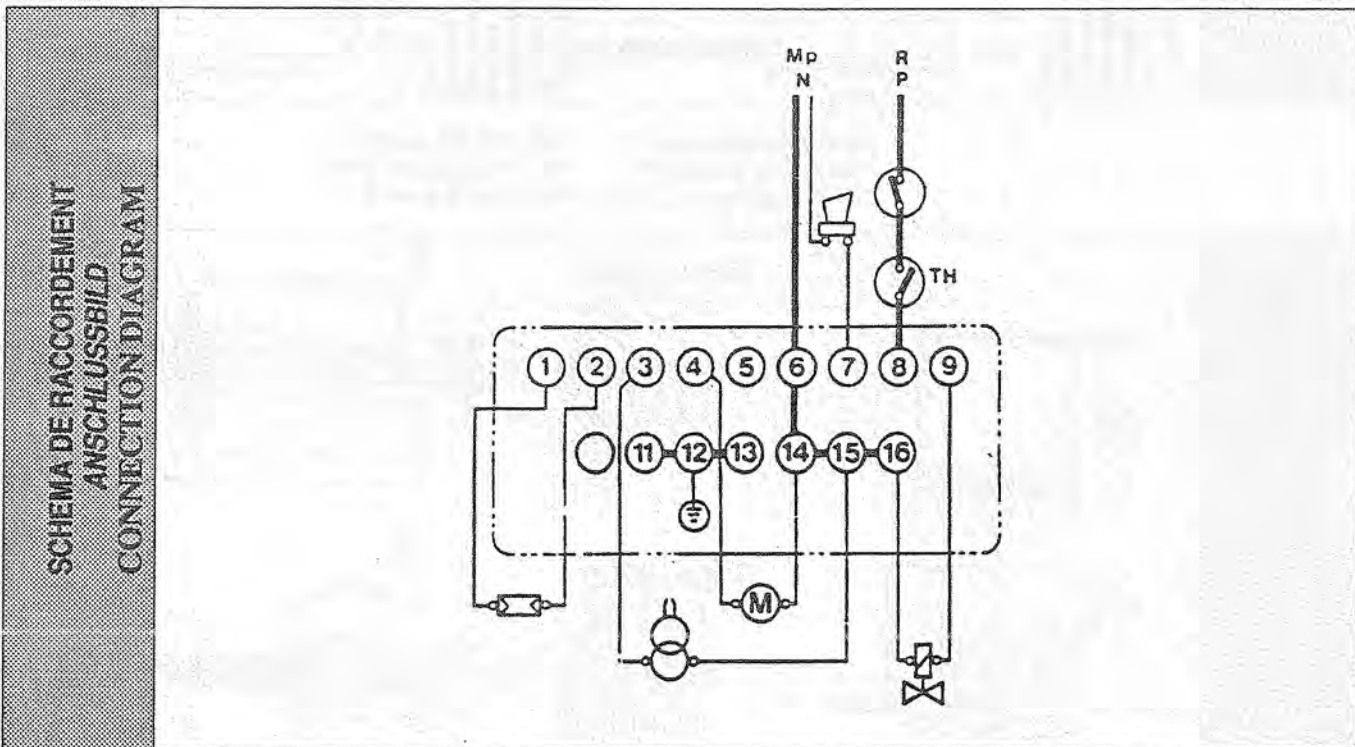

NF E 31302

FREMDLICHT SICHERHEIT MIT STÖRABSCHALTUNG

GUARDS AGAINTS FALSE LIGHT START UP WITH SAFETY LOCKOUT.

RENSEIGNEMENTS TECHNIQUES TECHNISCHE DATEN GENERAL DETAILS	U: 220 V/240 V +10% -15% f: 50-60 Hz	 220 V/240 V 4 A  220 V/240 V 2 A  220 V/240 V 2 A	  Type: 8209 ou 8207 ≥ 15 lux T° ≤ 70°C (158° F)
	Préventilation Vorlüftung Pre-purge t3 ~ 10s* Pré-allumage Vorzündung Pre-ignition	Post-allumage Nachzündung Post-ignition t2 ~ 3s* Temps de sécurité Sicherheitszeit Safety lock-out time t1 < 10s	* Ces temps sont variables avec la tension d'alimentation et la température ambiante * Diese Angaben sind variabel entsprechend des Spannung und der Umgebungstemperatur * These timings vary with the voltage and the ambient temperature.



SYMBOLES SYMBOLE SYMBOLS	 Moteur à brûleur Brenner Motor Burner motor	 Transformateur Zündtransformator Transformer	 Alarme Störsignal Alarm	 Electrovanne Magnetventil Solenoid valve
	 Cellule Flammenfühler Photocell	 TH Thermostat Temperatur Regler Room Thermostat		

SCHEMA DE PRINCIPE
SCHALTBEILD
SCHEMATIC WIRING DIAGRAM



DIAGRAMME DE FONCTIONNEMENT
SCHALTPROGRAMM
OPERATIONAL DIAGRAM

Avec préventilation - Mit Vorlüftung - With prepurge

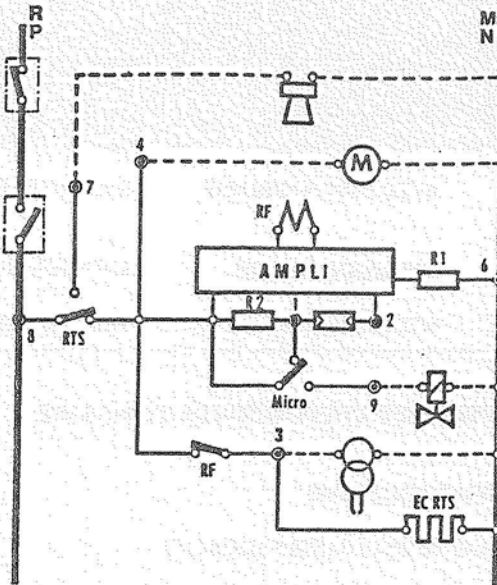
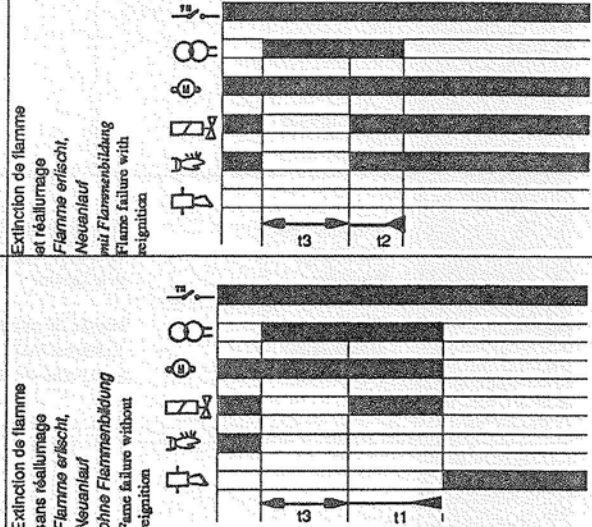
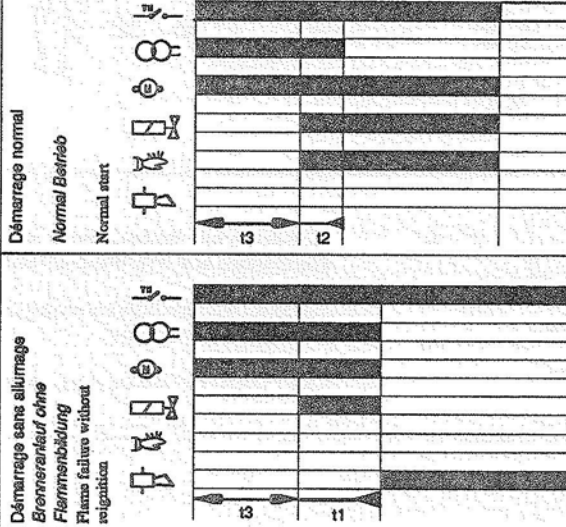

Sur demande livrable en : 100, 110, 200 ou 240 V
Auf anfrage lieferbar für : 100, 110, 200 oder 240 V
Can be supplied on demand for : 100, 110, 200 or 240 V

ENCOMBREMENT
MASSBILD
DIMENSIONS

